

Saddlebag Support Bars – Kawasaki VN1700 Classic

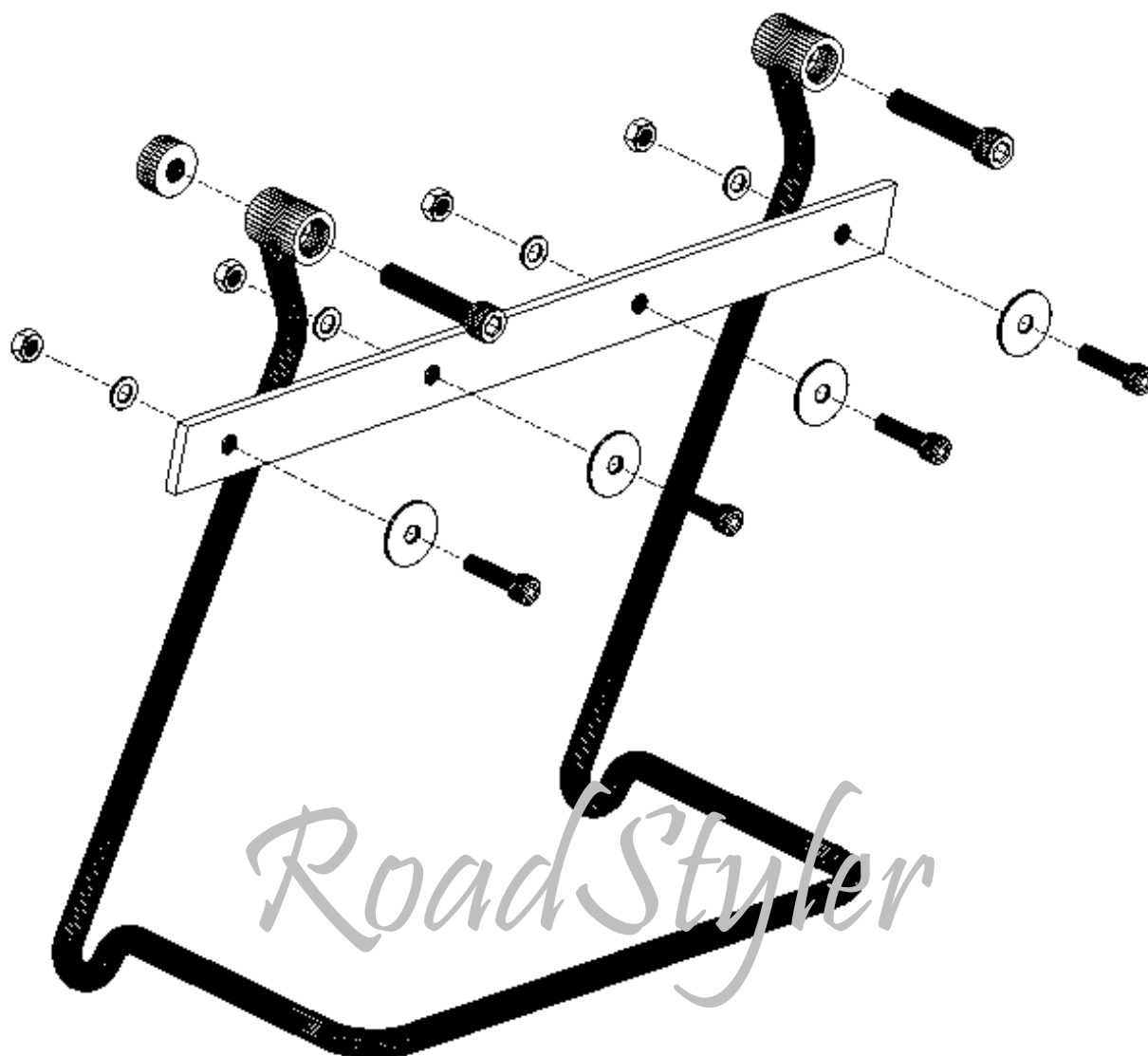

General information and comments:

1. Do not tighten the screws too tight.
2. Tighten all main 2 screws at the end - after assembling the entire structure on a motorcycle.
3. Always check the screw length and pitch - compare to the original. The final length of the screw depends on the installed components on the bike.
4. **WARNING: After installation check whether support bar (or saddlebag) will not hit the overhang elements of the motorcycle (eg belt or cardan shaft) while driving!** You can order from us the additional spacers.